

# SUBPLATE

TYPE ES3B12... AND ES3C14

## BASE SINGOLA

TIPO ES3B12... ED ES3C14



3

Subplate, A-B side ports 1/2"G, P-T rear ports 1/2"G, with relief valve. (RV) Weight = 3 kg  
 Base singola con utilizzi A-B laterali da 1/2"G, P-T posteriori da 1/2"G  
 con valvola limitatrice di pressione. Peso = 3 Kg

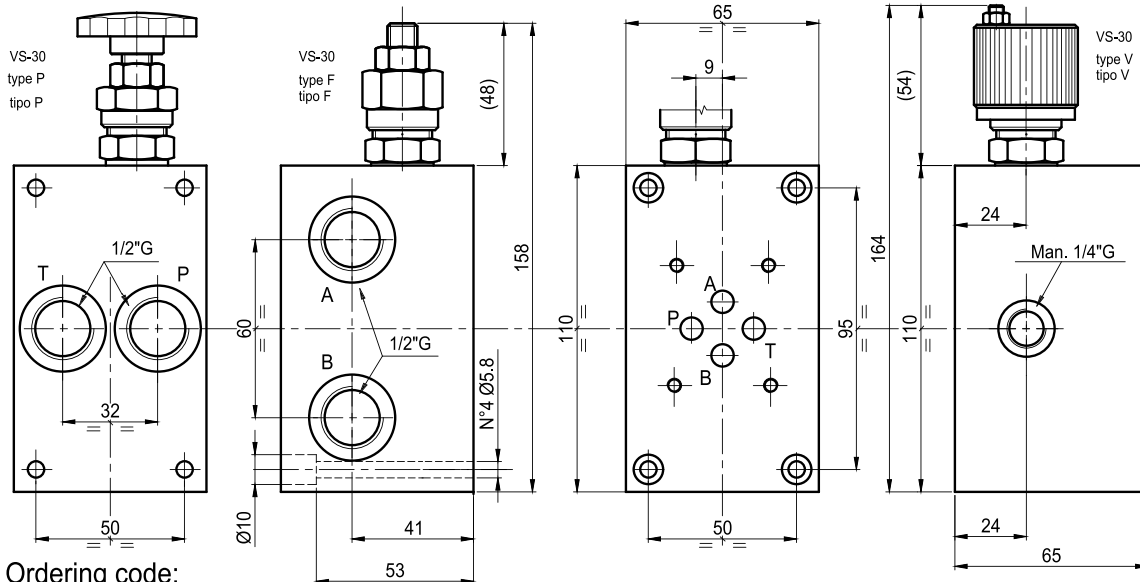

Ordering code:

Esempio di ordinazione:

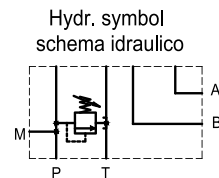
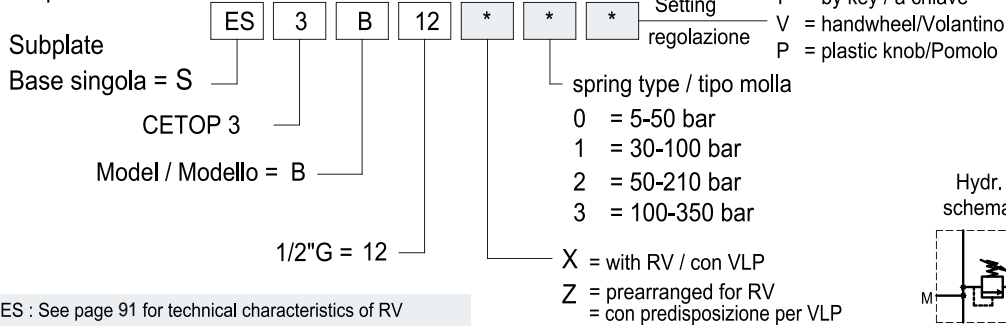

NOTES : See page 91 for technical characteristics of RV  
 NOTA: Per informazioni tecniche relative alla VLP vedere pag 91

Subplate with A-B-P-T back ports, 2 fixing screws. Weight 0.9 kg  
 Base singola con utilizzi A-B-P-T posteriori da 1/4" G.  
 Peso = 0.9 Kg

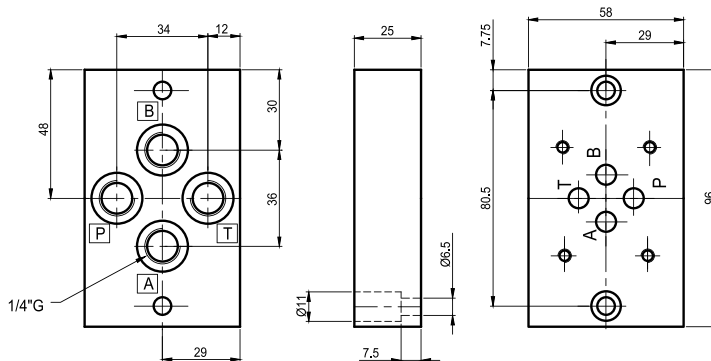

Ordering code:

Esempio di ordinazione:

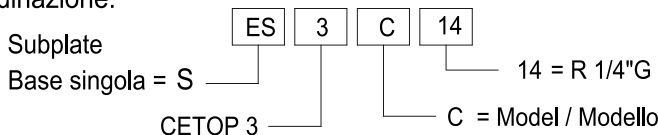

Hydr.symbol schema idraulico



SUBPLATE  
 BASE SINGOLA